



The Effect of the Digital Economy on Indecent Work in Indonesia 2019

Y P A Risky¹, N W K Projo²

¹Politeknik Statistika STIS, Jakarta, Indonesia

²Politeknik Statistika STIS, Jakarta, Indonesia

*Corresponding author's e-mail: 211710078@stis.ac.id, nucke@stis.ac.id

Abstract. The emergence of the digital economy is indicated to affect the employment sector. The job opportunities created by the digital economy provide an opportunity for workers to work in poor jobs, full of risks and indecent works. This study aims: first, to describe the economic digital and indecent work conditions in Indonesia. Second, to investigate the direct influence of infrastructure and digital media on the digital economy. Third, to examine the direct impact of the digital economy on indecent work. The data used is secondary data with observations from 34 provinces sourced from BPS and other ministries. Using the SEM-PLS analysis method, the results show that infrastructure and digital media positively impact the digital economy. Similarly, the digital economy, reflected by e-commerce sellers and buyers, has a positive and significant relationship to indecent work as reflected by Employment Excessive Working Time (EEWT), Precarious Employment Rate (PER), and non-union workers. It can be said that the increase in the digital economy influences the conditions of indecent work.

1. Introduction

Since its introduction in 1996 by Don Tapscott, the digital economy is now growing. Even the digital economy is capable enough to contribute to increasing world income. This potential also occurs in Indonesia. The value of e-commerce transactions in Indonesia is predicted to continue to grow every year. It is even expected that in 2018 it can reach 144.1 trillion IDR and 237 trillion IDR in 2022 [1]. In addition, the supporting aspects of the digital economy in Indonesia also show a progressive development. In 2018, 93.9 percent of all Indonesian Internet Service Providers Association (APJII) survey respondents accessed the internet through their mobile phones [2]. Furthermore, in 2018 almost 40 percent of Indonesia's population had also used the internet [3]. This figure may continue rising because the Indonesian government, through the National Medium-Term Government Plan (RPJMN) for the 2020-2024 period, targets the digital economy's contribution to the GDP of 4.66 percent [4].

The digital economy has potential resources that may influence the employment sector. This indication is even more remarkable considering that the ease of economic transactions through the digital economy increases the demand for goods and services, affecting the use of labor following the Cobb-Dougllass law [5]. The influence of the digital economy on employment shows an adverse effect, and some offer a positive impact. As many as 52.6 million conventional jobs are potentially replaced by digital systems and cause an increase in the number of unemployed [6]. However, the economic growth of e-sales and e-commerce in 10 countries on the European continent positively impacts the development of labor demand, especially in technology and knowledge-based jobs [7]. On the other



hand, regardless of the positive or negative influence of the digital economy on the employment sector, it is indicated that the digital economy will continue to affect poor working conditions. As a form of negation of decent work, improper work can be defined as a job that does not guarantee every worker to work productively and human rights are not fulfilled [8].

Decent work is conceptualized by the International Labor Organization (ILO) into ten main elements: employment opportunities, adequate income and productive work, decent working hours, combining work, family, and personal life, work to be abolished, stability and job security, equal opportunity and treatment in employment, safe working environment, social security, and social dialogue as representatives of workers and employers. The indecent works use the negation of all decent job elements. From Figure 1, several indicators measure the main aspects of decent work from 2016 to 2019 and show unfavorable conditions. Indicators of Precarious Employment Rate (PER), Employment Population to Rate (EPR), and Low Pay Rate (LPR) during this period showed an increase. The increase in EPR accompanied by the rise in PER and LPR indicates that the existing job opportunities are not yet qualified to guarantee decent work. Moreover, when viewed from the development of social security indicators, which declined in 2019, it increasingly indicated that the availability of job opportunities had not been accompanied by the provision of social security for workers. Furthermore, when compared with the development of the digital economy, which continues to increase, this phenomenon supports that the digital economy is indicated to affect inadequate working conditions.

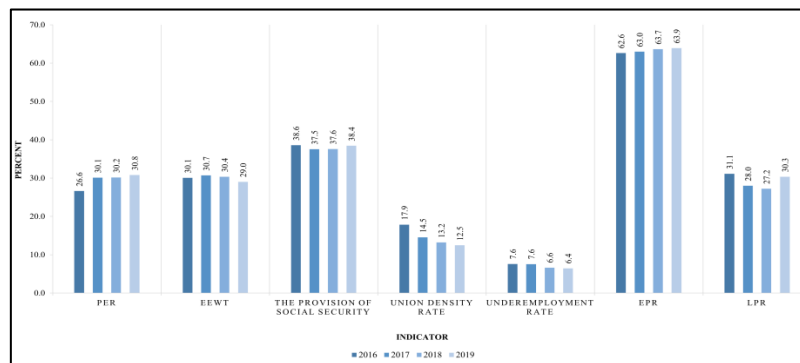

Figure 1. The decent work indicator in Indonesia, 2016-2019
Source: BPS Statistics Indonesia

Although, it cannot be denied that the phenomena and data related to the digital economy and its impacts have not been fully collected by the relevant institutions in Indonesia. However, by looking at the potential effects, exploratory research in this field is needed. Moreover, the vital role of decent work as SDGs pillars and poverty alleviation requires the government to form special regulations to protect workers. The Minister of Manpower stated that adaptive labor regulations related to decent work principles are needed to respond to changes in the digital economy era [9].

One of the studies that specifically discusses the relationship of e-commerce to decent work conditions is the research of Gultom et al. [10]. This literature study mentioned some indications along with the birth of the e-commerce platform: a reduction in the number of workers to be employed because they are replaced by machines, an increase in the mental stress level of workers because workers with low abilities are no longer needed, and the high inequality in the number of workers in the informal sector. Therefore, digitalization poses a security risk for these informal workers who do not have social security. Based on this research, the presence of e-commerce allows a reduction in the number of workers (downsizing). The effect of downsizing on decent work conditions has been further investigated by Osthus [11], and the results show that downsizing is closely related to job insecurity. Nam [12] with 2001 US baseline survey data obtained that technology significantly affects job insecurity and employee uncertainty and weakens the relationship between workers' psychological contracts with workers.



Based on the background we mentioned above, our research purposes are to describe the economic digital and indecent work conditions in Indonesia. The second is to investigate the direct influence of infrastructure and digital media on the digital economy. The third is to examine the digital economy's direct impact on indecent work. The paper's structure starts with the introduction part that describes the background and motives of the study. The hypothesis development is explained in the literature review and hypothesis section. The data source and Structural Equation Modelling are presented in the methodology section. The results section contains the study results and discussions. The last section is the conclusion section that provides the conclusion, implications, and research limitations.

2. Literature Review and Hypothesis

The digital economy has not yet been precisely defined and agreed upon by experts. The Organization for Economic Co-operation and Development (OECD), the Australian Department of Broadband, Communications and the Digital Economy (DBCDE) define the digital economy as a combination of technology and the range of economic and social activities that people carry out through the internet and related technologies [12]. A similar definition was also conveyed by the Bureau of Economic Analysis (BEA) that the digital economy is a transaction that is closely related to the internet and information, communication, and technology (ICT).

Other components support the process of digitizing the economy into a digital economy. Compared to other major components, infrastructure and digital media, e-commerce tends to be an essential focus for describing the digital economy. It is supported by Mesenbourg's research [14] which included an e-commerce component in the concept of a digital economy and other components, namely e-business infrastructure. The development of e-commerce cannot be separated from other components such as infrastructure and digital media. Stiawan's research [15] showed that the high number of computer users indicates many people are interested in business transactions from home. In line with this, Palinggi & C Limbongan [16], in their research, also found that micro-entrepreneurs use easier internet access to increase their income by buying/selling online. Meanwhile, digital media is also indicated to have a relationship with the development of e-commerce. Research conducted by Kaplan and Haenlein [17] concluded that social media (a form of free digital media) connecting many people easily becomes potentially attracts e-commerce entrepreneurs to promote goods to be sold and increase sales.

The influence of the digital economy on the employment sector comes in the form of potential and negative impacts. Gultom et al. [10] stated that one of the potentials of the digital economy is its ability to provide many risky job opportunities. Izdihar [18] found that along with the development of the digital economy, the demand for conventional labor in Indonesia is decreasing. Regardless of the potential and negative impacts, the digital economy is indicated to affect poor working conditions. The disappearance of some jobs will encourage workers to work in perfunctory employment. In contrast, creating skilled jobs does not guarantee that all workers will work productively and fulfill their rights. This statement is supported by BPS [19] that job loss is an incentive for the workforce to work perfunctorily by working in other forms of inappropriate work. Referring to the definition of decent work by the ILO, improper work is defined as work that does not guarantee the equality, freedom, security, and dignity of its workers as human beings.

Based on the explanation above, we propose several hypotheses as follows:

- H1: Infrastructure has a positive influence on e-commerce
- H2: Digital media has a positive impact on e-commerce
- H3: E-commerce positively affect the indecent work

3. Methodology

3.1. Scope of the research

This research focuses on forming a structural equation model of the relationship between the digital economy and indecent work. The unit of analysis is the 34 provinces in Indonesia, and 2019 is the year of observation. The variables in this study are latent, so the dependent variable is referred to as the endogenous construct. The independent variable is further referred to as the exogenous construct. A



latent variable or construct is an abstract concept that cannot be measured directly. It can only be observed indirectly through its effect on indicators [20].

Exogenous constructs in this study include infrastructure constructs and digital media constructs. At the same time, the endogenous construct consists of the construct of e-commerce and the construct of indecent work. Apart from being an endogenous construct, the e-commerce construct can also be used as an intervention construct. However, the limitation of the unit of observation becomes a limitation for building a too complex model. According to the rule of thumb, the number of samples for the SEM-PLS method is ten times the largest number of structural model paths directed at certain constructs in the structural model [20]. In measuring each construct, manifest variables (indicators) are used to reflect the condition of the construct. Overall, there are 16 indicators used with the following details: five reflect infrastructure constructs, two reflect digital media constructs, three reflect e-commerce, and six reflect indecent work (Appendix 1).

The scope of the analysis of indecent work in this study focuses on five elements, namely working hours, job stability and security, safe work environment, social security, and social dialogue. These five main elements are chosen by considering the influence of the digital economy on the emergence of non-standard and risky forms of work [10]. Meanwhile, the analysis on e-commerce will focus on e-commerce, including e-commerce sellers and buyers. It is considered sufficient because several previous studies use similar indicators [29].

3.2. Analysis Method

This study uses two analytical methods, namely descriptive analysis and inferential analysis. The descriptive analysis uses tables and graphs to describe the condition of each construct which is reflected by the indicators. The inferential analysis uses the SEM-PLS method with the path diagram construction, as shown in Figure 2.

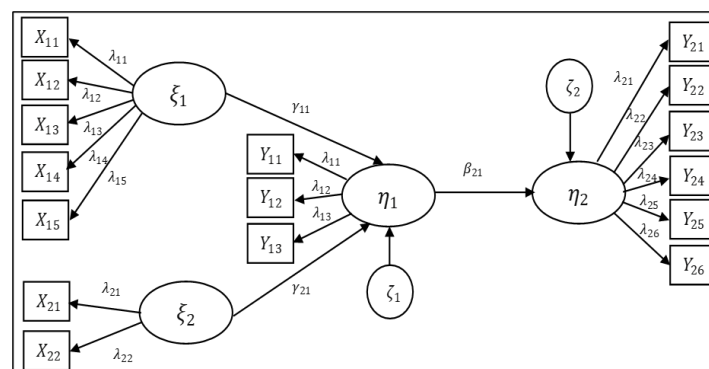

Figure 2. Path Diagram of Conceptual Framework Structural Equation

Before the analysis, we estimate the unpublished indicators from microdata. Those are PTL2, PTL3, PTL4, PTL5, and PTL6 (Appendix 1). All are calculated using a formula from BPS Statistics Indonesia and using weights. Next, the inferential analysis section will be explained as follows:

1. Conceptualization of the model by designing the relationship between indicators and constructs (measurement model) and the relationship between constructs (structural model) based on theoretical studies and literature review. The relationship between infrastructure and e-commerce based on Stiawan [15] dan Palinggi & C Limbongan [16]; social media relations and e-commerce based on the research of Kaplan and Haenlein [17] and BEA [13]; the relationship between e-commerce and indecent work is based on Gultom et al. [10], Nam [12], and Osthus [11]. Then the relationship is constructed in a path diagram (Figure 2) with the following equation:



Exogenous latent variables with reflective indicators:

$$X_{jh} = \lambda_{jh} \xi_j + \delta_{jh} \tag{1}$$

Endogenous latent variables with reflective indicators:

$$Y_{jh} = \lambda_{jh} \eta_j + \varepsilon_{jh} \tag{2}$$

The general form between endogenous latent variables:

$$\eta_j = \beta \eta_j + \Gamma \xi_j + \zeta_j \tag{3}$$

The relationship between infrastructure and digital media with e-commerce:

$$\eta_1 = \gamma_{11} \xi_1 + \gamma_{21} \xi_2 + \zeta_1 \tag{4}$$

The relationship of e-commerce with indecent work

$$\eta_2 = \beta_{21} \eta_1 + \zeta_2 \tag{1}$$

The β and γ are path coefficient; δ_{jh} , ε_{jh} , and ζ_j are the residuals from each equation.

2. Estimating the parameters of the SEM-PLS model, namely weight estimate, path estimate, as well as an average estimate (means estimate) and parameter location (parameter location)
3. Hypothesis testing by resampling bootstrap standard error, evaluating the results of resampling bootstrap on the measurement model and structural model by comparing the T-statistics value with the T-table value. If the indicators and constructs are valid and reliable, it is continued with the evaluation of the structural model. The criteria for all assessments are in Table 1 and Table 2. If they do not meet the requirements, re-construct the path diagram.
4. Obtaining the value of the factor score (path coefficient) of the significant model.

Table 1. Criteria, Measures, and Conditions for Evaluation of Reflective Measurement Models

Criteria	Measures	Conditions
Internal Consistency Reliability	<i>Cronbach's Alpha</i>	$Alpha \geq 0.6$
	Composite Reliability	Composite reliability coefficient > 0.7
Convergent Validity	<i>Outer Loading</i> (Indicator Reliability)	$Standard\ Outer\ loading\ t \geq 0.5$
	Extracted Average Variance (AVE)	$AVE > 0.5$
Discriminant Validity	<i>Cross-Loading</i>	The $Outer\ Loading\ indicator > Cross\ Loading$
	Fornell-Larcker	Square root AVE $>$ Correlation between latent constructs



Table 2. Criteria, Measures, and Conditions for Evaluation of Structural Models

Criteria	Measures	Conditions
Non-Colinearity	VIF	$VIF < 5$, tolerance = 0.2
Structural Model Significance	<i>t-value</i>	Hypothesized positive relationships (one-tail)
	<i>p-value</i>	$t - statistics > t_{\alpha(n-p)}$, $\alpha = 5\%$
Predictive Accuracy	R^2	$P - value < 0.05$
Effect Size f^2	f^2	$R^2 \geq 0.75$ (substantial); $0.5 \leq R^2 < 0.75$ (moderate); $0.25 \leq R^2 < 0.5$ (weak)
Predictive Relevance	Q^2	$f^2 \geq 0.35$ (large effects); $0.15 \leq f^2 < 0.35$ (medium effects); $0.02 \leq f^2 < 0.15$ (small effects); $f^2 < 0.02$ (there is no effect)
Effect Size q^2	q^2	$Q^2 > 0$, the path model's predictive relevance for a particular dependent construct; $Q^2 \leq 0$, the path model's lacks predictive relevance for a particular dependent construct; with omission distance (D) = 7
		$q^2 \geq 0.35$ (large effects); $0.15 \leq q^2 < 0.35$ (medium effects); $0.02 \leq q^2 < 0.15$ (small effects)

More concisely, Figure 3 is a flow diagram of the data analysis process carried out.

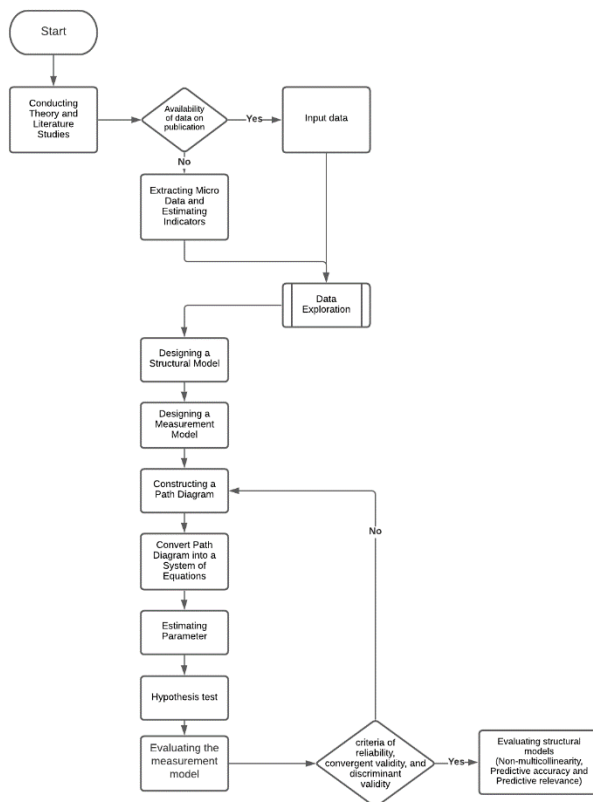

Figure 3. Flowchart of the Formation of Structural Equation Model the Effect of the Digital Economy on Indecent Work

4. Results

4.1. Overview of the Digital Economy and Indecent Work

The emergence of the digital economy in Indonesia is indicated to bring changes to the community's economic activities. The process of adapting technology in the implementation of the digital economy, especially in e-commerce companies, poses a dilemma about the effects that exist. Technology that continues to develop and the inability of workers to adapt makes workers vulnerable to being left out.



In addition, this can also lead to a new pattern of work relations and the absence of a work contract that can cause workers to become economically vulnerable or known as a form of unskilled work. The following will describe the condition of several indicators that represent the condition of the digital economy and inadequate employment.

4.1.1. Infrastructure. Digital economy infrastructure is supporting infrastructure for the sustainability of digital economic activities. The digital economy infrastructure includes technology and digitization in the form of wireless communication tools/mobile phones (HP), computers, and the interconnected network (internet). In addition, infrastructure can also be in the form of investment in the ICT sector through capital expenditures for the ICT sector and internet access service points. The development of infrastructure in each province in Indonesia shows different conditions and even tends to be unequal. Except for the internet access service point, eastern Indonesia offers lower scores than the national average for these indicators. A large number of internet access service points in the east region comes from the massive provision of internet access in public places (schools, health centers, and village halls) in border areas and frontier areas, following the procurement principle of the Ministry of Communication and Information, outermost, and lagging (3T) [21]. Meanwhile, the condition of good infrastructure is indicated by the indicators that are still dominant in the islands of Java and Sumatra, particularly the DKI Jakarta Province and the Riau Archipelago Province. An illustration of one of the indicators that build the infrastructure construct, namely the internet user indicator, is presented in Figure 4.

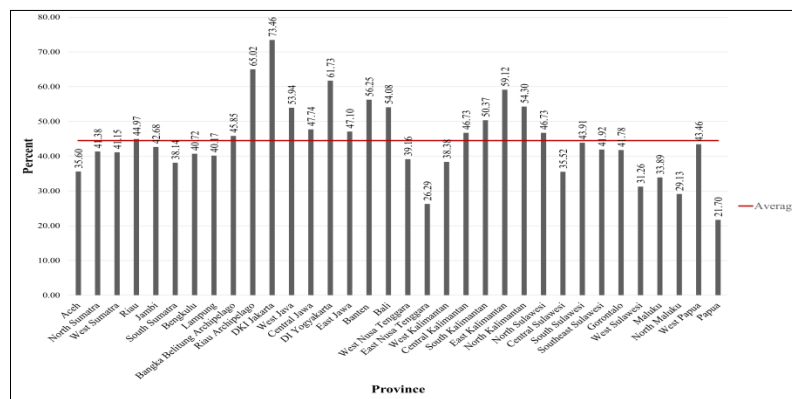

Figure 4. Percentage of Internet Users in Indonesia 2019

4.1.2. Digital Media. The development of technology and information provides changes in the form of information distribution. Information that is previously obtained through print media, such as newspapers, or sound, such as radio, is now digitized in a container called digital media. The condition of digital media development in all provinces shows fairly evenly distributed results on information media indicators. Still, it offers an unequal value for the eastern region on social media indicators. The disparity in this indicator is exacerbated by establishing several policies related to the use of social media in the Java Island region, especially the D.I Province. Yogyakarta. The implementation of the Jogja Smart Province concept as a grand design by Governor D.I. Yogyakarta aims to stimulate innovation on all fronts by utilizing digital technology for all aspects of service [22]. This concept requires the people of Yogyakarta D.I Province to adapt more quickly and make digital technology a necessity, including social media. The picture of the inequality in the percentage of social media users is depicted in Figure 5.

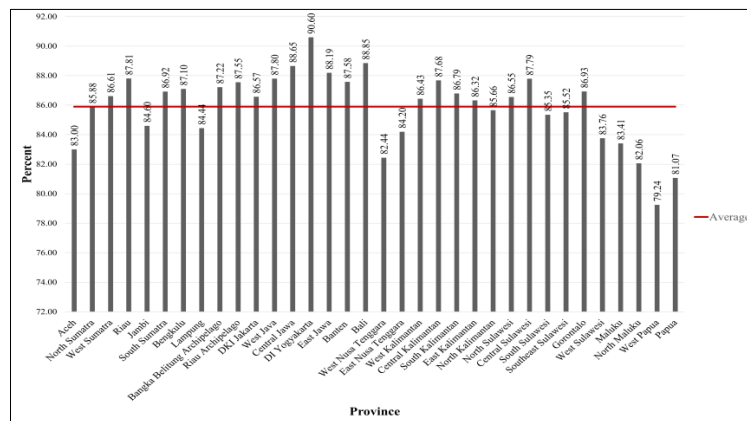

Figure 5. Percentage of Internet Users Using the Internet for Social Media in Indonesia 2019

4.1.3. *E-Commerce.* The condition of e-commerce as a proxy for the digital economy shows a reasonably good shape in several provinces. All indicators used to reflect e-commerce have a national average of 12.46 percent for the user indicator, 11.84 percent for buyers, and 4.21 percent for e-commerce sellers. This condition is much lower than the predicted transaction value and total e-commerce retail sales released by e-marketers and Statista. However, this vast difference does not necessarily make one of the data wrong or inaccurate considering the methods used by the two are also different. Of the 34 provinces, the Province of D.I Yogyakarta owns the highest score for all indicators with a percentage value of 25.42 percent for users, 20.37 percent for buyers, and 10.62 for sellers. These high values are supported by the fact that in terms of infrastructure and digital media, D.I. Yogyakarta also shows excellent potential. Based on the publication of Thematic Gender Statistics: Profile of the Indonesian Millennial Generation [23] D.I. Yogyakarta also managed to have the highest percentage value of millennial entrepreneurs who use internet media to sell goods and services with a percentage of 15.01 percent. The description of e-commerce sellers and buyers in Indonesia is depicted in Figure 6.

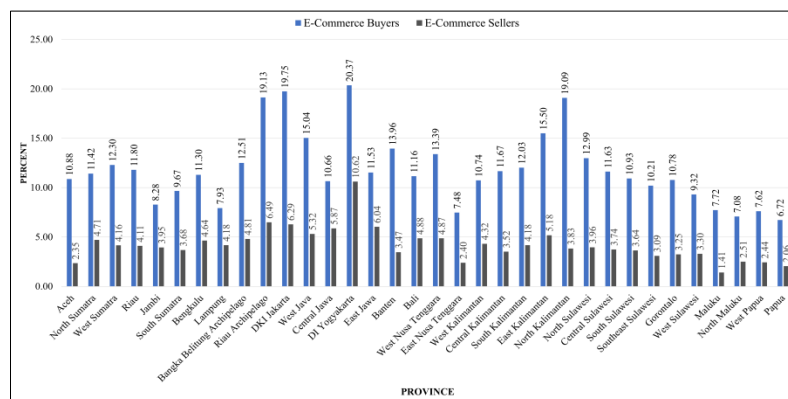

Figure 6. Percentage of Indonesian E-commerce Buyers and Sellers 2019

4.1.4. *Indecent Work.* The absence of decent work measurement toppled with the complexity of the goals of the decent job makes the measure of decent work only refer to indicators released by the ILO and BPS Statistics Indonesia. Noted that the decent work objectives are reflected in the four pillars of rights at work, full and productive work, social protection, and social dialogue) Of the nine elements presented by BPS Statistics Indonesia, this study uses five elements with six leading indicators. These



six indicators are the Underemployment Rate (TSP) and EEWT to represent the element of decent working hours, PER to represent the element of stability and job security, Workers without Social Security to represent the element of social security, Percentage of Workers with Health Complaints to represent elements of a safe work environment. And Workers Not Members of Trade Unions to represent elements of social dialogue as representatives of workers and employers.

The condition of each indicator is quite diverse in each region. As an illustration in Figure 7 is described the PER indicator. Although the indicator values are pretty various, a conclusion can be drawn that 4 out of 6 PTL indicators in the eastern region tend to have reasonably low values compared to others. This condition can be interpreted that in the five elements of PTL, the working conditions in the eastern region are more feasible than the others. Two indicators that place the east region with a score that tends to be higher are the indicator for workers without social security and the CSR indicator. Meanwhile, from the high indicator values in the western region, the Riau Islands Province, DKI Jakarta Province, and West Java Province rank relatively stable on several indicators. When compared with the conditions of e-commerce in Figure 6, the three provinces also occupy a relatively high position. The existence of e-commerce in an area also increases the conditions of indecent work in that area.

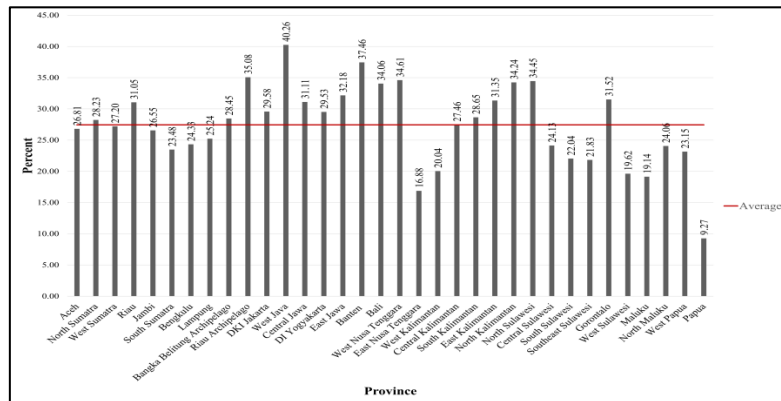

Figure 7. The Precarious Employment Rate in Indonesia 2019

4.2. Structural Equation Modeling: The Effect of the Digital Economy on Decent Work

The structural model of the influence of the digital economy on decent work is composed of two exogenous latent variables: infrastructure (ξ_1), digital media (ξ_2) and two latent endogenous variables: e-commerce (η_1), indecent work (η_2). The construction of the path diagram is following Figure 2. After constructing the relationship in the analysis using SEM-PLS, the next step is to estimate the measurement model. The estimation results obtained are depicted in Figure 8.

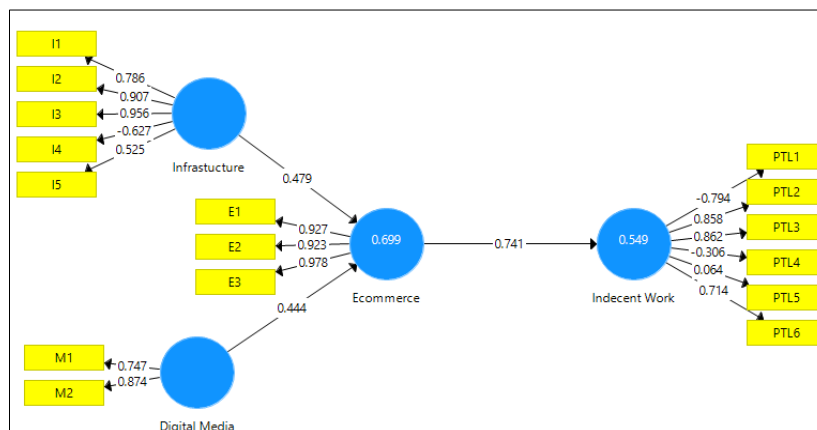



Figure 8. Measurement and Structural Model Path Diagram

Each construct is described using reflective indicators so that in interpreting Figure 6 in an equation, one of them can be written as follows:

Infrastructure construct with HP user reflective indicators

$$X_{11} = 0.786 \xi_1 + \delta_{11} \tag{6}$$

Furthermore, the constructs and their associated indicators are written in the same way. Before estimating the structural model (inner model I), the measurement model is first evaluated to ensure that the indicators used to reflect the latent variables are reliable and valid. The evaluation criteria that will be carried out include internal consistency (reliability), convergent validity, and discriminant validity. In evaluating internal consistency, Cronbach's Alpha criteria and composite reliability are used. Based on Table 1, conclusions are obtained from the measurement of these criteria in Table 3.

Table 3. Internal consistency reliability criteria

Latent Variables	Composite Reliability	Cronbach's Alpha	Notes	
			Composite Reliability	Cronbach's Alpha
Infrastructure	0.768	0.481	Fulfilled	Not fulfilled
Digital media	0.795	0.495	Fulfilled	Not fulfilled
E-Commerce	0.894	0.937	Fulfilled	Fulfilled
Indecent work	0.363	0.510	Fulfilled	Not fulfilled

From this measurement, the path model that has been constructed does not meet the reliable criteria. It means that each indicator still needs to be re-evaluated to conclude which indicator is better eliminated. The following evaluation is the criteria for convergent validity. Convergent validity is calculated using two measures, namely outer loading and AVE. Using the rules in Table 1, from all the outer loading values, the path diagram coefficients in Figure 8, several indicators do not meet the criteria. Maintaining indicators that do not meet the requirements can affect the content validity of the constructed constructs. Therefore, these indicators are eliminated. The eliminated indicators are I4, PTL1, PTL4, and PTL5. After being eliminated, the model evaluation is carried out again until the size is obtained in Table 4. The elimination of indicators increases the measurement value and makes the evaluation of the re-specification results meet the criteria, except for Cronbach's Alpha criteria for digital media constructs. However, constructs with Cronbach's Alpha value of less than 0.6 can still be used considering the composite reliability value that has been met Hair et al. [20]. Meanwhile, in the e-commerce construct, Cronbach's Alpha criteria show a substantial value. Hair et al. [20] stated that Cronbach's Alpha with more than 0.9 indicates that the measure used is derived from the exact measurement and allows measurement bias to arise. The e-commerce User indicator (E3) is eliminated to reduce the bias. This indicator is chosen with the consideration that some e-commerce users may also be e-commerce buyers. The results of the second re-specification evaluation are written in Table 5, and it can be seen that the criteria have been met.

Table 4. Comparison of AVE and Initial Model Composite Reliability and First Specification

	AVE	AVE Respesification	Composite Reliability	Respesification Composite Reliability	Cronbach's Alpha	Respesification Cronbach's Alpha
Infrastructure	0.605	0.668	0.768	0.885	0.481	0.823
Digital media	0.660	0.660	0.795	0.794	0.495	0.495



<i>E-Commerce</i>	0.889	0.889	0.894	0.960	0.937	0.937
Indecent work	0.453	0.739	0.363	0.895	0.510	0.823

Table 5. The AVE, Composite Reliability, dan *Cronbach's Alpha* Second Re-specification

	AVE	Composite Reliability	<i>Cronbach's Alpha</i>
Infrastructure	0.668	0.886	0.823
Digital media	0.660	0.795	0.495
<i>E-Commerce</i>	0.866	0.928	0.846

The respecified model is evaluated using cross-loadings and Fornell-larcker criteria to assess its discriminant validity. Discriminant validity is carried out to determine how far the difference between one construct and another construct is. The cross-loading criteria are met if the outer loading value is greater than the cross-loading value. In Appendix 2, the entire value of the outer loading of each indicator on the latent variable is greater than the value of the cross-loading. Furthermore, the Fornell-Lacker criterion works by comparing the square root of the extracted mean value of variance (AVE) with the correlation of the latent variables. Based on Table 6, the square root value of AVE is on the diagonal of the table and shows a greater value than the correlation of latent variables with other constructs. So, it can be concluded that the constructs share more variance with related indicators than with other constructs, and the reflective constructs already meet discriminant validity.

Table 6. Fornell-Lacker (Square Root of Extracted Average Variance)

	<i>E-Commerce</i>	Infrastructure	Digital media	Indecent work
Infrastructure	0.931			
Digital media	0.807	0.817		
<i>E-Commerce</i>	0.717	0.627	0.831	
Indecent work	0.701	0.758	0.583	0.860

After all indicators and constructs have been valid and reliable, we get the structural model estimation. The structural model is evaluated to see the predictive ability or the suitability of the model that has been built. Estimates were made using the bootstrapping method with 5,000 replications and a significance level of 5 percent. The null hypothesis being tested is that there is no effect between latent variables. Suppose the p-value is less than the significance level. In that case, it can be concluded that there is sufficient evidence stating the relationship between latent variables at a significance level of 5 percent. Based on Table 7, it can be seen that all paths of the structural model are significant with a p-value of less than alpha, which means that there is a relationship between latent variables.

Table 7. Structural Model Path Coefficient

	<i>Original Sample (O)</i>	T-Statistics	<i>P-Value</i>
Infrastructure → <i>E-Commerce</i>	0.589	5.877	0.000
Digital media → <i>E-Commerce</i>	0.349	2.490	0.006
<i>E-Commerce</i> → Indecent work	0.701	8.689	0.000

If the model is written in the form of a linear equation, the structural equation will be obtained as follows:



$$Ecommerce = 0.589 Infrastructure^* + 0.349 Digital media^* + \zeta_1$$

$$Indecent work = 0.701 Ecommerce^* + \zeta_2$$

*Significant at $\alpha = 0.05$

The model that has been built is then evaluated using the criteria of non-multicollinearity, predictive accuracy, and predictive relevance. A good model is a model that does not have collinearity between constructs, so the bias caused by this collinearity does not interfere with the modeling. Based on Table 8, it can be concluded that all constructs have met these criteria. Furthermore, predictive accuracy and predictive relevance can be seen in Table 9. It is supposed that the structural model built has predictive accuracy and predictive relevance, which is quite good and fulfilled so that the structural model building can be studied further to get more information related to the relationship between constructs.

Table 8. Structural model VIF construct

	<i>E-Commerce</i>	Indecent work
Infrastructure	1.647	-
Digital media	1.647	-
<i>E-Commerce</i>		1.000

Table 9. Values R^2 , f^2 , Q^2 and q^2 of Structural Model

Latent Variables	R^2	Criteria R^2	f^2	Criteria f^2	Q^2	Criteria Q^2	q^2	Criteria q^2
Infrastruktur	-	-	0.75	Large	-		0.404	Large
Media Digital	-	-	0.25	Medium	-		0.120	Medium
<i>E-commerce</i>	0.73	Moderate	-		0.599	Fulfilled	-	
Indecent work	0.50	Moderate	-		0.332	Fulfilled	-	

4.3. Relationship of Infrastructure and Digital Media to E-commerce and E-commerce to Decent Work

The estimation results of the structural model show that the infrastructure constructs and digital media both have a significant influence on e-commerce. In the infrastructure construct, the path coefficient is 0.589, while in the digital media construct, the path coefficient is 0.349. This positive path coefficient value means that the constructs of e-commerce and digital media positively influence the e-commerce. This finding follows the findings of Gumah and Jamaluddin [24] that the increase in internet users, as a form of infrastructure, indicates the development of public access to support the development of digital economic activities. Meanwhile, the findings related to digital media follow the results of Sharma and Aggarwal [25] which, show that buyers whose cognitive satisfaction is met with information on goods/services will repeat purchases at the same e-commerce or called repurchase.

The structural model of the relationship between e-commerce and unskilled work shows a path coefficient of 0.701. The positive path coefficient in this model can be interpreted that the increase in e-commerce as reflected by e-commerce buyers and sellers will have a positive effect on inadequate working conditions as reflected in the Employment Excessive Working Time (EEWT), Precarious Employment Rate (PER), and Workers Not Members of Trade Unions. This positive effect is in line with the findings of Gultom [10] that the presence of e-commerce poses a significant risk of changing job opportunities due to e-commerce. It is because extensive job opportunities will reduce the quality of human labor, especially for low-demand workers. This influence can be indicated as a chain effect of the demand and supply in the labor market due to an increase in the demand for goods or services. Employers respond to the rise in demand due to technology by adding labor. Still, the marginal



product of labor (VMPE) is greater than the wage to be paid (W) in the addition of labor, requiring employers to seek profits by hiring workers without contracts (gig workers) and increase working hours. Gig worker is a term for a short contract, freelance, outsourcing, and "on-demand work" systems. As a non-standard form of work, gig workers have vulnerabilities and non-fulfillment of decent work standards such as sufficient and predictable income [26]. Based on the report on the results of the 2018 e-commerce insights & salary survey conducted by the Cranberry Panda institution in 2018 [27], on average, 53 percent of e-commerce workers experienced more than 2 hours of working hours per week. This continuous increase in working hours will reduce worker productivity and interfere with personal life and relationships with family [28]. Therefore, it is included as one of the indications of an increase in indecent working conditions.

5. Conclusions

The e-commerce and its components in 34 provinces of Indonesia show good scores. Meanwhile, the conditions of work that are not feasible offer a high enough value, meaning that the work requirements in Indonesia can be said to need to be reviewed for feasibility. In the description of the two variables, it can be seen that the value of infrastructure and digital media indicators in several provinces is in line with the value of each e-commerce indicator in that province. In addition, several e-commerce indicators in several provinces also show values that are in line with the values of several indicators of decent work in those provinces. Furthermore, valid and reliable indicators are obtained to reflect each variable. The percentage of HP/Wireless users, the rate of computer users, the percentage of internet users, and capital expenditures in the ICT sector reflect the condition of infrastructure. Information media and social media reflect the condition of digital media. Meanwhile, the percentage of e-commerce buyers and sellers reflects e-commerce. In the case of non-decent work, there are EEW, PER, and Workers Not Members of Trade Unions as indicators that reflect the indecent work.

Through the structural equation with a significance of five percent, there is a positive and significant relationship between the infrastructure and digital media constructs on the e-commerce construct. The government should provide and build infrastructure and provide easy internet access for every Indonesian community. The result shows positive and significant relationship between the e-commerce construct and the improper work construct. So, it can be said that the existence of the digital economy in Indonesia has not provided an optimal influence on decent work conditions in Indonesia. We recommend the government to consider the following policies: hourly wage policy to ensure workers with more controlled working hours have their welfare under control, policies to monitor companies conducting electronic trading activities so as not to exploit gig workers, promote trade union promotions to make workers aware on the importance of trade unions, and promote training for workers to improve workers' abilities so they are not easily left out by technology.

Further research may add indicators of the value of e-commerce transactions and other forms of digital media and complement the elements of inappropriate work studied by covering all aspects to see the digital economy's influence on indecent work from a broader perspective.

Acknowledgments

Authors would like to thank Politeknik Statistika STIS, BPS Statistics Indonesia for their full support regarding this research.



Appendix

Appendix 1. Details of Latent Variables and Research Indicators

Latent Variables	Manifest Variables (Indicators)	Code	Source
Infrastructure (ξ_1)	Percentage of Mobile Phones (HP) or Wireless Communication Users	I1	Publication of People's Welfare Statistics
	Percentage of Computer Users	I2	Publication of People's Welfare Statistics
	Percentage of Internet Users	I3	Publication of People's Welfare Statistics
	Number of Internet Access Location	I4	BAKTI Ministry of Communication and Informatics
	Number of Capital Spending Realization for ICT	I5	DJPK Ministry of Finance
Digital Media (ξ_2)	Percentage of Internet Users Using the Internet for Information Media	M1	Publication of People's Welfare Statistics
	Percentage of Internet Users Using the Internet for Social Media	M2	Publication of People's Welfare Statistics
<i>E-commerce</i> (η_1)	<i>E-commerce</i> Buyers	E1	Publication of People's Welfare Statistics
	<i>E-commerce</i> Sellers	E2	Publication of People's Welfare Statistics
	<i>E-commerce</i> Users	E3	Publication of People's Welfare Statistics
Indecent Work (η_2)	<i>Underemployment Rate</i>	PTL1	Publication of Labor Market Indicator
	<i>Employment Excessive Working Time (EEWT)</i>	PTL2	National Labor Force Survey August 2019
	<i>Precarious Employment Rate (PER)</i>	PTL3	National Labor Force Survey August 2019
	Percentage of Workers Without Social Security	PTL4	National Labor Force Survey August 2019
	Percentage of Workers with Health Complaints	PTL5	National Social and Economic Survey March 2019
	Percentage of Workers Without Workers' Association	PTL6	National Labor Force Survey August 2019



Appendix 2. Cross-Loading and Outer Loading Values of Reflective Indicators

	Digital Media	Ecommerce	Indecent Work	Infrastructure
E1	0.643	0.940	0.687	0.839
E2	0.696	0.921	0.613	0.652
I1	0.415	0.534	0.735	0.777
I2	0.598	0.781	0.588	0.927
I3	0.686	0.838	0.809	0.953
I5	0.200	0.346	0.243	0.549
M1	0.747	0.486	0.254	0.461
M2	0.873	0.663	0.642	0.552
PTL2	0.358	0.544	0.825	0.773
PTL3	0.505	0.622	0.931	0.635
PTL6	0.621	0.634	0.821	0.566

References

- [1] Economics O 2017 Digital Spillover: Measuring the True Impact of the Digital Economy. United Kingdom: Huawei and Oxford Economics.
- [2] APJII 2018 Today's Portrait, Indonesian Internet Users & Behavior *APJII* **23** pp. 1–7
- [3] World Bank 2018 Individuals using the Internet (% of population) [cited 15 Des 2020] Available from: <https://data.worldbank.org/indicator/IT.NET.USER.ZS?end=2019&locations=ID&start=1990>
- [4] Ministry of National Development Planning, & National Development Planning Agency 2019 *Technocratic Design RPJMN 2020-2024* (Jakarta: Bappenas)
- [5] Mankiw N G 2006 *Macroeconomic*, Translate: Fitria Liza, Imam Nurmawan (Jakarta: Erlangga)
- [6] Manyika J, Chui M, Miremadi M, Bughin J, George K, Willmott P, & Dewhurst M 2017. A Future That Woks: Automation, Employment, And Productivity. *McKinsey Global Institution, January*, pp 1–28.
- [7] Biagi F, and Falk M. 2017. The impact of ICT and e-commerce on employment in Europe. *Journal of Policy Modeling*, **39**(1), pp 1–18
- [8] International Labour Organization 2012 Decent Work Profile in Indonesia. Geneva: ILO
- [9] Agustini A E. Bali Tribune [newspaper on internet] 2018 Oct. 9 [cited 2021 Jan 20], Public, National, Available from: <https://balitribune.co.id/content/menaker-sebut-digitalisasi-ekonomi-berdampak-pada-perubahan-pergeseran-tenaga-kerja>
- [10] Gultom O, Schneider K, & Preis L M 2018 *Digital Economy, Expectations and Threats Learning from Indonesia*
- [11] Osthus S 2007 For better or worse? Workplace changes and the health and well-being of Norwegian workers *Work, Employment, and Society* **21**(4) pp 731–750
- [12] Nam T 2018 Technological Forecasting & Social Change Technology usage, expected job sustainability, and perceived job insecurity. *Technological Forecasting & Social Change, July*, pp 1–11.
- [13] Barefoot K, Curtis D, Jolliff W, Nicholson J R, & Omohundro R 2018 Defining and Measuring the Digital Economy, Working Paper (Washington, D.C.: BEA (Bureau of Economic Analysis))
- [14] Mesenbourg T L 2001 Measuring the Digital Economy.
- [15] Stiawan D 2002 *E-Commerce*.



- [16] Palinggi D, and C Limbongan E 2020 The Effect of the Internet on the E-Commerce Industry Regulations for the Protection of Customer Personal Data in Indonesia. *Seminar Nasional Riset dan Teknologi*, pp 225-232.
- [17] Kaplan A M, and Haenlein M 2010 Users of the world, unite! The challenges and opportunities of Social Media. *Business Horizons*, **53(1)**, pp 59–68
- [18] Izdihar A T 2019 E-Commerce Impact on the Shifting of Labor Demand in Indonesia 2015-2017. *Advances in Economics, Business and Management Research*, **98(Icot)**, pp 195–199
- [19] Central Bureau of Statistics 2019 *Decent Work Indicators in Indonesia 2019* (Jakarta: BPS)
- [20] Hair J F, Hult G T M, Ringle C M, and Sarstedt M 2016 Partial least squares structural equation modeling with R. In *Practical Assessment, Research and Evaluation* **21** (Issue 1)
- [21] Ministry of Communication and Information [article on internet] 2018 May 15th [cited 29th March 2021]. Available on: https://www.kominfo.go.id/content/detail/13279/pemerataan-pembangunan-infrastruktur-telekomunikasi-kawasan-indonesia-timur-segara-terwujud/0/sorotan_media
- [22] Ministry of Communication and Informatics (Kemenkominfo) Berita Kominfo [newspaper on internet] 2019 April 25 [cited on 27 March 2021], Public, National, Available on : https://www.kominfo.go.id/content/detail/18279/yogyakarta-akan-jadi-ujungtombak-ekonomi-digital/0/berita_satker
- [23] Central Bureau of Statistics 2018 *Thematic Gender Statistics: Indonesian Millennial Generation Profile* (Jakarta: the Ministry of Women's Empowerment and Child Protection)
- [24] Gumah M E, dan Jamaluddin Z 2006 What is the Digital Economy, and How to Measure it. *E-Proceedings of Knowledge Management International Conference and Exhibition*, **1**, pp 378–382
- [25] Sharma H, dan Aggarwal A G 2019 Finding determinants of e-commerce success: a PLS-SEM approach. *Journal of Advances in Management Research*
- [26] Bell D N F, and Blanchflower D G 2021 Underemployment in the United States and Europe. *ILR Review*, **74(1)**, pp 56–94
- [27] Cranberry Panda [article on internet] 2018 Oct 15th [cited 2th7 December 2020] Available on : <https://www.cranberrypanda.co.uk/ecommerce-blog-post/overtime-and-work-life-balance-in-ecommerce>
- [28] Central Bureau of Statistics 2017 *Decent Work Indicators in Indonesia 2017* (Jakarta: Central Bureau of Statistics)
- [29] Liu S 2013 An empirical study on e-commerce's effects on economic growth. *International Conference on Education Technology and Management Science*, pp 81–84